

TF4AI

Image Size: $\frac{1}{3}$ $\frac{1}{4}$

[SPECIFICATIONS]

Focal Length :	4mm	Input Impedance :	High Impedance
Maximum Relative Aperture :	1:1.2	Operation :	Focus : Manual
Iris :	F1.2 - Approx. 360 (With ND Spot Filter)	Iris :	EE (DC+8.5 to 16V : Fixed Voltage, Max40mA) Speed Within 4sec.(Auto Close System)
Sensitivity Adjustment :	0.5 - 1.5Vp-p(Image Signal)	EE Mechanism :	The built-in EE Amp amplifies the difference between the video signal from the camera and the preset Iris signal level. It causes the Iris to change size.
Angular Field of View :	70.7 X53.4 deg.	EE Accuracy :	With Input Video Signal 0.7Vp-p Within+/-10% of Mean Value
Image Format :	4.8X3.6mm(D6mm)	Operation Temperature :	-10 to +50
Minimum Object Distance :	0.2m(From Front Vertex)	Mount :	CS-Mount(Adjustable Lens Position)
Object Dimensions at M.O.D. :	29.6X21.3cm	Front Thread :	30.5mm P0.5
Optical Back Focal Distance :	9.0mm(In Air)	Size, Weight :	51X41.5X36.1mm, Approx. 50g
Flange Back :	12.5mm		
Input Signal :	Composite Video Signal or Video Signal		
Photometry Range :	Approx. 40% - 70% Variable to Vp-p		

[COMPOSITION]

- Lens1
- Lens Cap1
- Dust Cap1

[DIMENSIONS]

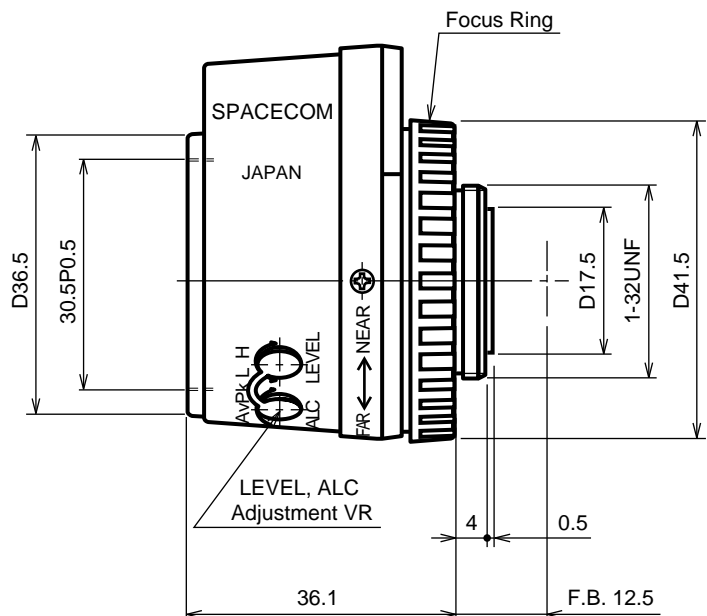
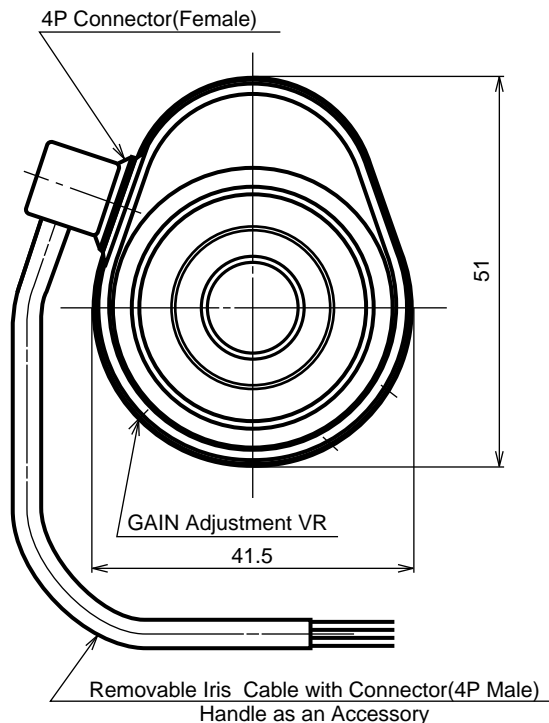

Unit:mm

[CIRCUIT DIAGRAM]

