

TF8DC

Image Size: $\frac{1}{3}$ $\frac{1}{4}$

[SPECIFICATIONS]

Focal Length :	8mm	Flange Back :	12.5mm
Maximum Relative Aperture :	1:1.2	Operation Voltage :	Close to Open : Less than 3V Open to Close : More than 0.5V
Iris :	F1.2 - Approx. 360 (With ND Spot Filter)	Operation :	Focus : Manual Iris : IG(Auto Close System)
Angular Field of View :	37.5 X27.7 deg.	Operation Temperature :	-10 to +50
Image Format :	4.8X3.6mm(D6mm)	Mount :	CS-Mount(Adjustable Lens Position)
Minimum Object Distance :	0.1m(From Front Vertex)	Size, Weight :	D30X33.7mm, Approx. 50g
Object Dimensions at M.O.D. :	7.9X6.0cm		
Optical Back Focal Distance :	10.7mm(In Air)		

[COMPOSITION]

- Lens1
- Lens Cap1
- Dust Cap1

[DIMENSIONS]

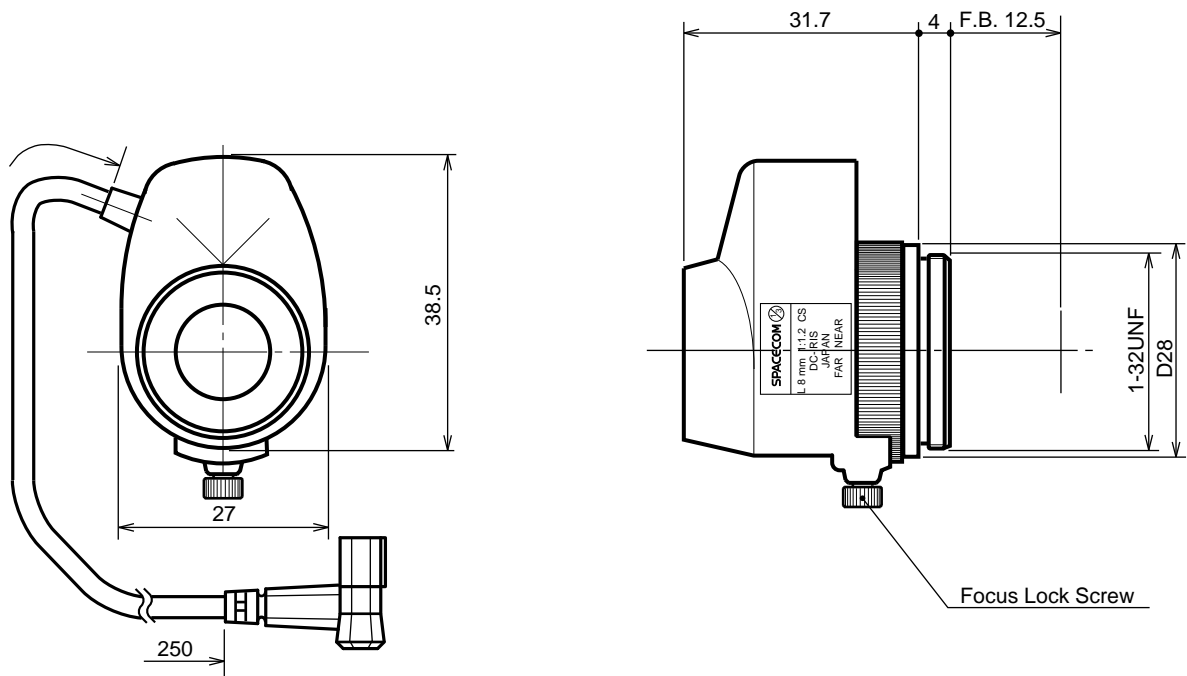

Unit:mm

[CIRCUIT DIAGRAM]

