



Acuva Series

AcC 36DX568-I67

- IMX568 CMOS Pregius S Sensor
- 5 MP
- Trigger via GMSL2
- M12x0.5 Mount
- IP67 Ingress Protection

The Acuva Series camera AcC 36DX568-I67 with a Sony IMX568 sensor delivers 55 frames per second with a resolution of 2448x2048 (5 MP).

Vision at the Speed of Innovation – The Imaging Source's latest GMSL2 cameras feature high-speed data transfer of up to 6 Gbps, robust coaxial cables of up to 15 m length, IP67-rated housings, and FAKRA connectors – designed for reliable imaging in harsh environments in automotive, robotics, agriculture, and other embedded and industrial vision systems.

To help you accelerate development and reduce complexity, The Imaging Source collaborates with trusted partners like Neosys Technology and ConnectTech. Our Acuva GMSL2 cameras and accessories are fully compatible with their industrial PCs (IPCs), ensuring seamless integration and reliable performance right out of the box. These partnerships are designed to save you time, minimize integration effort, and give you a competitive edge. Because when our technologies work together, you succeed faster.

Note: This Data Sheet is intended to provide a summary overview for an individual camera model. The Imaging Source's website also offers information on spectral sensitivity, dimensional diagrams, sensor data sheets, STEP files as well as our full product catalog. For comprehensive technical information, please refer to the Technical Reference Manual specific to each camera model.

www.theimagingsource.com



1 Quick Facts

General	
Resolution	2448x2048
Dynamic Range	10 bit
Frame Rate at Full Resolution	55

Optical Interface	
IR-Cut filter	No
Sensor Type	Sony IMX568-AAQJ-C
Shutter Type	Global
Sensor Format	1/1.8 inch
Pixel Size	2.74 μm
Lens Mount	M12x0.5

Electrical Interface	
Interface	GMSL2
Supply Voltage	10 VDC to 20 VDC
Current Consumption	approx 95 mA @ 12 VDC

Mechanical Data	
Dimensions	H: 36 mm, W: 36 mm, L: 60.3 mm
Mass	80 g
Protection Class	IP6K6, IP6K7 (ISO 20653) *

*) Protection only while The Imaging Source IP67 FAKRA cable is connected to the camera.

Environmental Conditions	
Temperature (operating)	-5 °C to 45 °C
Temperature (storage)	-20 °C to 60 °C
Humidity (operating)	20 % to 80 % (non-condensing)
Humidity (storage)	20 % to 95 % (non-condensing)



Dimensional Diagrams

2 Dimensional Diagrams

2.1 AcC 36DX568-I67 without Tripod Adapter

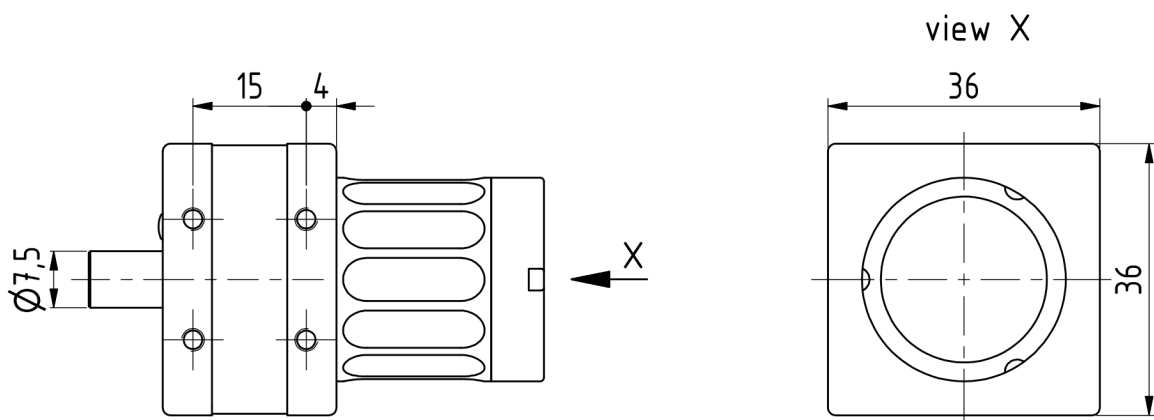

*) available in different lengths

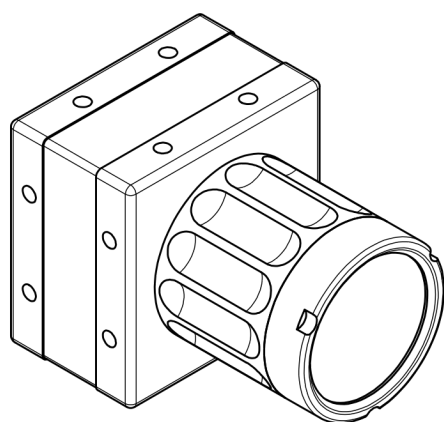
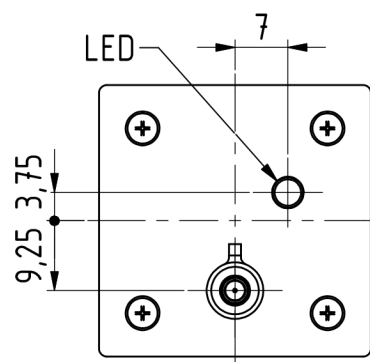
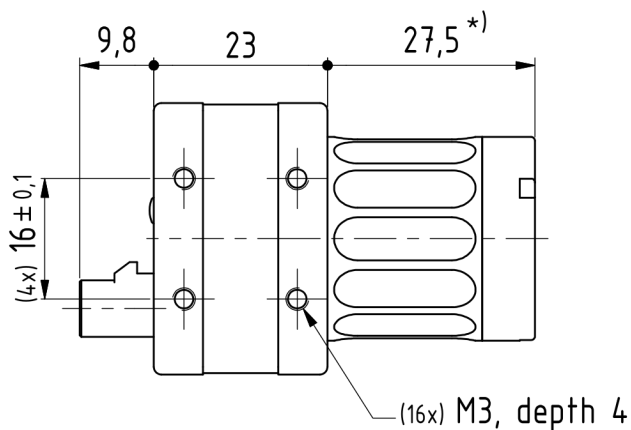

Scale: 1 : 1
Dimensions: mm
Tolerances: DIN ISO 2768-m
275-20-1-01-00-c (w/o tripod-adapter)





3 Spectral Characteristics

3.1 Spectral Sensitivity - IMX568-AAQJ-C

